

Bell (Bright Brass Finish)

Description	Stock#
Passage	B5F10
Privacy	B5F40
Dummy Trim	B5F170
Key-In-Knob	B5F51

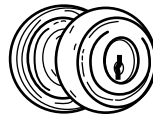

Georgian (Bright Brass Finish)

Description	Stock#
Passage	G5F10
Privacy	G5F40
Dummy	G5F170
Key-In-Knob	G5F51

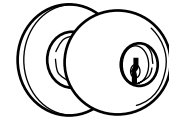

Orbit (Bright Brass Finish)

Description	Stock#
Passage	OR5F10
Privacy	OR5F40
Dummy	OR5F170
Key-In-Knob	OR5F51
Key/Keyless	ORKN150

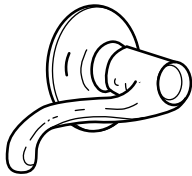

Flair (Bright Brass Finish)

Description	Stock#
Passage Right Hand	F5F10R
Passage Left Hand	F5F10L
Privacy Right Hand	F5F40R
Privacy Left Hand	F5F40L
Dummy Right Hand	F5F170R
Dummy Left Hand	F5F170L

Georgian (Antique Brass Finish)

Description	Stock#
Passage	G9F10
Privacy	G9F40
Dummy	G9F170
Key-In-Knob	G9F51

Georgian/Flair (Bright Brass Finish)

Entry door hardware with Georgian knob on exterior, flair handle interior.

Description	Stock#
Key-In-Knob Right Hand	GF5F51R
Key-In-Knob Left Hand	GF5F51L

Orbit (Chrome Finish)

Description	Stock#
Passage	OR26F10
Privacy	OR26F40
Dummy	OR26F170
Key-In-Knob	OR26F51

Orbit/Flair (Bright Brass Finish)

Entry door hardware with Orbit knob on exterior, flair handle interior.

Description	Stock#
Key-In-Knob Right Hand	ORF51R
Key-In-Knob Left Hand	ORF51L

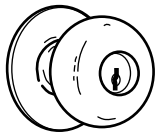

Plymouth (Bright Brass Finish)

Description	Stock#
Passage	P5F10
Privacy	P5F40
Dummy	P5F170
Key-In-Knob	P5F51
Key/Keyless	PKN150



Key-In-Knob door handles are available with either a square corner latch or a drive-in latch. Please specify your preference when ordering.

Deadbolts (Bright Brass Finish)

Description	Stock#
Single 160	DB5160
Single 460	DB5460
Double 160	DB5162
Double 460	DB5462

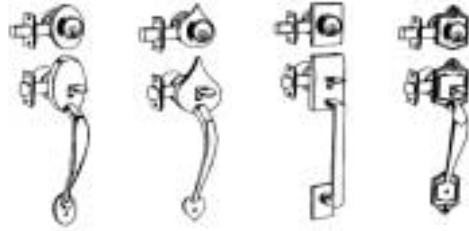

Plymouth Bedford Century Parthenon

Deadbolts (Antique Brass Finish)

Description	Stock#
Single 160	DB9160
Single 460	DB9460
Double 160	DB9162
Double 460	DB9462

Entrance Handles (Bright Brass Finish)

Description	Stock#
Plymouth	EHP5F158
Bedford	EHB5F158
Century	EHM5F158
Parthenon	EHP9F158

Deadbolts (Chrome Finish)

Description	Stock#
Single 160	DB26160
Single 460	DB26460
Double 160	DB26162
Double 460	DB26462

Inside Trim (Bright Brass)

Description	Stock#
Bell	B5F359
Flair, Right Hand	F5F359R
Flair, Left Hand	F5F359L
Georgian	G5F359
Orbit	O5F359
Plymouth	P5F359

Door Bell Button

Description	Stock#
Plymouth, Bright Brass	DBBP5

Door Knocker

Description	Stock#
Plymouth, Bright Brass	DKP5

Escutcheon

Description	Stock#
Outside Escutcheon, Bright Brass	ESC5
Outside Escutcheon, Antique Brass	ESC9
Westlake, Bright Brass	60536003

Pocket Door Locks

Description	Stock#
Passage, Bright Brass	60546100
Passage, Antique Brass	60946100
Privacy, Bright Brass	60546101
Privacy, Antique Brass	60946101
Privacy, 625	62546101

For other types of door hardware, see the *Schlage* catalog.

Lock Keying Kit

Description	Stock#
Schlage Lock Keying Kit	KK

Blank Key

Description	Stock#
Schlage Blank Key	BK

Web Links
The Schlage Lock Company
www.schlage.com

 *Deadbolts are available with either a square corner latch or a drive-in latch. Please specify your preference when ordering.*



Flexible Door Stop

Description	Stock #
3" Bright Brass	060BB
3" Antique Brass	060AB
3" Chrome	060C



Flush Pull

Description	Stock #
1 5/16" x 3 1/8" Bright Brass	22BB
2 1/8" Bright Brass	221BB
2 1/8" Antique Brass	22AB

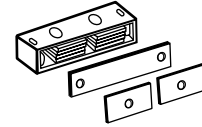

Heavy-Duty Magnetic Catch

Description	Stock #
Steel (Double)	MCD
Steel (Single)	MCS



Traditional Door Stop

Description	Stock #
#6 3" Bright Brass	61BB
#6 3" Antique Brass	61AB
#6 3" Chrome	61C



Handrail Bracket

Description	Stock #
Bright Brass	HB BB
Antique Brass	HB AB



Coat and Hat Hook

Description	Stock #
Bright Brass	CHBB
Antique Brass	CHAB

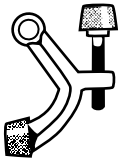

Hinge Pin Door Stop

Description	Stock #
#70 Bright Brass	70BB
#70 Antique Brass	70AB
#70 Chrome	70C

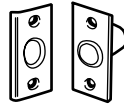

Ball Catch with Strike

Description	Stock #
2 1/2" x 1 3/8" Bright Brass	347BB
2 1/2" x 1 3/8" Antique Brass	347AB



Door Pull

Description	Stock #
Bright Brass	218BB

Common Applications*

Joining	Size & Type	Placement
Wall Framing:		
Top plate	8d common 16d common	
Header	8d common 16d common	
Header to joist	16d common	
Studs	8d common	
	16d common	
Wall Sheathing:		
Boards	8d common	6" o.c.
Plywood (⁵ / ₁₆ " , ³ / ₈ " , ¹ / ₂ ")	6d common	6" o.c.
Plywood (⁵ / ₈ " , ³ / ₄ ")	8d common	6" o.c.
Subflooring	8d common	10"-12" o.c.
Underlayment	1 ¹ / ₄ " x 14 ga. annular underlayment nail	6" o.c. edges 12" o.c. face
Roof Framing:		
Rafters, beveled or notched	12d common	
Rafter to joist	16d common	
Joist to rafter and stud	10d common	
Ridge beam	8d & 16d common	
Roof Sheathing:		
Boards	8d common	
Plywood (³ / ₁₆ " , ³ / ₈ " , ¹ / ₂ ")	6d common	12" o.c. and 6" o.c. edges
Roofing, Asphalt:		
New construction	⁷ / ₈ " through 1 ¹ / ₂ "	4 per shingle galv. roofing
Re-roofing application	1 ³ / ₄ " or 2" galv. roofing	4 per shingle
Roofing, Wood Shingles:		
New construction	3d-4d galv. shingle	2-3 per shingle
Re-roofing application	5d-6d galv. shingle	2-3 per shingle
Soffit:		
	6d-8d galv. common	12" o.c. max.
Siding:		
Bevel and lapped	9d galv. common hot dipped	
Drop and shiplap	8d galv. common hot dipped	
Shingles and shakes	3d-6d galv. shake hot dipped	
Plywood, fiberboard, gypsum	2" x 14 ga. Hot dipped galv. shake	
Doors, Windows, Mouldings:		
	4d-12d casing-finishing	

Joining	Size & Type	Placement
Furring:		
Wood strip to masonry	1 ¹ / ₂ " or 1 ³ / ₄ " concrete nail	
Wood strip to stud or joist	8d common	
Paneling:		
Wood	4d-8d casing-finishing	24" o.c.
Hardboard	2" x 16 ga. annular	8" o.c.
Plywood	3d casing-finishing	8" o.c.
Gypsum	1 ¹ / ₄ " annular drywall	6" o.c.
Lathing	4d common blued	4" o.c.

**NOTE: Usage may vary somewhat due to regional differences and preferences.*

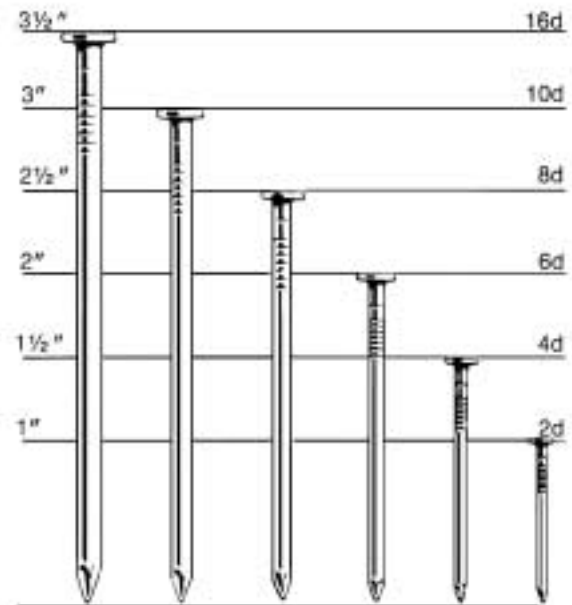

Sizes

Nail sizes start at 2d, which is 1" long. They range up to 60d size, which is 6" in length. The 2d through 10d are in ¹/₄" increments, i.e., 2d is 1" long; 3d is 1 ¹/₄", etc. Nails above 16d increase by ¹/₂" increments.

Surface Finishes

Bright:

After manufacture, nails are tumbled to remove dirt and "chips" and packed uncoated.

Galvanized:

A zinc coating is applied, via either hot-tumbler method or electrolysis, to protect against atmospheric corrosion.

Cement-Coated:

An adhesive is applied via tumbler to provide increased holding power.

Blued:

Nails are sterilized by heating them until an oxidation layer is formed.



Common Nails

All rough and heavy construction, such as wall and roof framing, concrete forms, etc.

Description	Quantity	Stock #
6D	5#	6CM5
6D	50#	6CM
6D	1#	6CM1
7D	5#	7CM5
8D	5#	8CM5
8D	50#	8CM
10D	5#	10CM5
10D	50#	10CM
12D	5#	12CM5
12D	50#	12CM
16D	5#	16CM5
16D	50#	16CM
20D	5#	20CM5
20D	50#	20CM

Cap Nails



For attaching felt paper, house wrap, black vapor barrier, and similar applications.

Description	Quantity	Stock #
1" Round Head Steel	50#	1RH
1" Round Head Plastic	2,000	1KAP
1 1/2" Round Head Steel	50#	112RH
1 1/2" Round Head Plastic	2,000	112KAP
1 1/2" Square Head Steel	50#	112SH
2" Round Head Plastic	2,000	2KAP



Finish Nails

Used in cabinetry, paneling, or anywhere head must be concealed.

Description	Quantity	Stock #
3D	1#	3FN1
3D	5#	3FN5
4D	1#	4FN1
4D, Galvanized	1#	4GF1
4D	5#	4FN5
6D	1#	6FN1
6D	5#	6FN5
8D	1#	8FN1
8D	5#	8FN5
10D	1#	10FN1
10D	5#	10FN5
16D	1#	16FN1
16D	5#	16FN5



Box Nails, Galvanized

Use where thin, dry wood will be nailed close to its edge.

Description	Quantity	Stock #
3D	1#	3GB1
3D	5#	3GB5
4D	1#	4GB1
4D	5#	4GB5
6D	1#	6GB1
6D	5#	6GB5
7D	1#	7GB1
7D	5#	7GB5
7D	50#	7GB
8D	1#	8GB1
8D	5#	8GB5
8D	50#	8GB
12D	5#	12GB5
16D	1#	16GB1
16D	5#	16GB5
16D	50#	16GB
20D	5#	20GB5



Coated Sinker Nails

Used in rough and heavy construction, such as wall and roof framing. Coating provides added holding power.

Description	Quantity	Stock #
4D	1#	4CC1
4D	5#	4CC5
6D	1#	6CC1
6D	5#	6CC5
6D	50#	6CC
7D	1#	7CC1
7D	5#	7CC5
7D	50#	7CC
8D	1#	8CC1
8D	5#	8CC5
8D	50#	8CC
10D	5#	10CC5
10D	50#	10CC
12D	5#	12CC5
12D	50#	12CC
16D	1#	16CC1
16D	5#	16CC5
16D	50#	16CC



Deck Nails, Ardox Galvanized

Use with preservative-treated wood in outdoor applications.

Description	Quantity	Stock #
8D	5#	8GD5
8D	25#	8GD
10D	5#	10GD5
10D	25#	10GD
16D	5#	16GD5
16D	25#	16GD
20D	5#	20GD5
20D	25#	20GD



Casing Head Nails, Galvanized

Similar to finishing nails but hardened with dulled point to allow penetration of toe-strips and trim.

Description	Quantity	Stock #
6D	5#	6GC5
8D	5#	8GC5
16D	5#	16GC5
16D	50#	16GC



Underlayment Nails

For attaching plywood underlayment.

Description	Quantity	Stock #
1 1/4"	5#	11UL5
2"	5#	2UL5
1 1/4" RS	1#	114UL1



Siding Nails, Ardox Galvanized

For attaching shake siding or hardboard.

Description	Quantity	Stock #
8D	5#	8GS5
8D	25#	8GS
10D	5#	10GS5
10D	25#	10GS



Pole Barn Nails

Ring shank and hardened tip.

Description	Quantity	Stock #
6" RS HT	5#	6PB5
8" RS HT	1#	8PB1



Roofing Nails, Galvanized

Used to secure shingles or roofing to the underlayment.

Description	Quantity	Stock #
1"	1#	1GR1
1"	5#	1GR5
1 1/4"	5#	114GR5
1 1/4"	50#	114GR
1 1/2"	1#	112GR1
1 1/2"	5#	112GR5
1 1/2"	50#	112GR
2"	5#	2GR5
2 1/2"	1#	212GR1



Duplex Head Nails

Used for temporary structures, such as concrete forms or scaffolding.

Description	Quantity	Stock #
8D	5#	8DP5
8D	50#	8DP
16D	5#	16DP5
16D	50#	16DP



Joist Hanger Nails

Description	Quantity	Stock #
1 1/2"	1#	112HN1
1 1/2"	5#	112HN5
1 1/2"	50#	112HN



Stainless Steel Siding Nails

Description	Quantity	Stock #
8D	5#	8SS5



Masonry Fluted Nails

Used to attach studs and furring strips to walls.

Description	Quantity	Stock #
1"	5#	1FM5
1 1/2"	5#	112FM5
2"	5#	2FM5
2 1/2"	5#	212FM5



Masonry Hard Cut Nails

Used to attach studs and furring strips to walls.

Description	Quantity	Stock #
4D	5#	4HC5
7D	5#	7HC5
8D	5#	8HC5
10D	5#	10HC5



Drywall Nails

Description	Quantity	Stock #
1 5/8"	5#	158DW5
1 5/8"	50#	158DW
1 3/8"	5#	138DW5

Paneling Nails

Used for wood paneling.

Description	Quantity	Stock #
White 1"	360	1W
White 1 5/8"	200	158W
Black 1"	360	1BL
Black 1 5/8"	200	158BL
Brown 1"	360	1BR
Brown 1 5/8"	200	158BR
Cherry 1"	200	1BG
Cherry 1 5/8"	200	158BG
Tan 1"	360	1T
Tan 1 5/8"	200	158T

Corrugated Nails

Used for wood frames or furniture.

Description	Quantity	Stock #
3/8"	100	CN38
1/2"	100	CN12
5/8"	100	CN58

NAIL GUN NAILS

BOSTICH Strip

This nail will accommodate the BOSTICH N80S Framing Strip Nailer. Used primarily for general purpose framing, decking, and sheathing.

Description	Quantity	Stock #
S6D 2" Coated	2M	501130
S6D 2" Galvanized	2M	503130
S8D 2 1/2" Coated	2M	501150
S8D 2 1/2" Galvanized	2M	502150
S10D 3" Coated	2M	501170
S10D 3" Galvanized	2M	502170
S12D 3 1/4" Coated	2M	501180
S12D 3 1/4" Galvanized	2M	503180
S6D 3 1/2" Coated	2M	501190

BOSTICH Coil Nails

This nail will accommodate the BOSTICH N80C Framing Coil Nailer only. Used for framing, decking, and sheathing.

Description	Quantity	Stock #
6D Coated	3.6M	507131
8D Coated	2.7M	507151
8D Galvanized	3.6M	511151
10D Galvanized	2.7M	514171
12D Coated	2.7M	507181
12D Galvanized	2.7M	511181
1 1/4" Roof Galvanized	7.2M	611070
1 1/2" Roof Galvanized	7.2M	611090

BOSTICH Finish Nails

This nail is used with the BOSTICH N60FN Finish Gun only.

Description	Quantity	Stock #
1 1/4"	3,655	519070
1 1/2"	3,655	519090
1 3/4"	3,655	519110
2"	3,655	519130
2 1/2"	3,655	519150

Generic Strip

This nail is a clip head nail that accommodates the HITACHI NR83AA, PALSLODE GN-212 or SK-312, and SENCO SN2 or SN4.

Description	Quantity	Stock #
6D 2" Coated	4M	600130
8D 2 3/8" Coated	5M	600150
8D RS Galvanized	5M	601151
10D RS Galvanized	2.5M	601171
10D 3" Coated	2.5M	600170
16D Coated	2.5M	600190
16D RS Galvanized	2.5M	601191

Generic Nail Gun Finish Nails

Used in cabinetry, paneling, or anywhere head must be concealed. This nail will accommodate the SENCO L Series Finish Gun only.

Description	Quantity	Stock #
4D Senco	4M	603090
6D Senco	4M	603130
8D Senco	4M	603150

SCREWS

Hex Tapcon Screws

Description	Quantity	Stock #
3/16" x 1 3/4" w/Bit	100	HHT134C
3/16" x 1 3/4"	Bulk	HHT134B
1/4" x 2 3/4" w/Bit	100	HHT234C
1/4" x 2 3/4"	Bulk	HHT234B



Trim Head Screws

Description	Quantity	Stock #
#6 2 1/4"	150	THS214C
#7 1 5/8"	150	THS158C



Deck Screws

Description	Quantity	Stock #
#6 2" Grey	5#	2GDS5
#8 2 1/2" Grey	2,500	GDS212B
#8 2 1/2" Grey	5#	212GDS5
#8 3" Grey	2,000	GDS3B
#8 3" Grey	5#	3GDS5
#10 3 1/2" Grey	1,000	GDS312B



Self-Drill Screws

Description	Quantity	Stock #
7/16" Pan Head	100	PHS716
7/16" Pan Head	2M	PHS716C
1 1/4"	100	SD114
1 5/8"	100	SD158
3"	100	SD3

Tapcon Screw Anchors

Description	Quantity	Stock #
3/16" x 1 3/4" Phillips Head w/Bit	100	PHT134C
3/16" x 1 3/4" Phillips Head	Bulk	PHT134B
3/16" x 2 3/4" Phillips Head w/Bit	100	PHT234C
3/16" x 2 3/4" Phillips Head	Bulk	PHT234B
Drill Bit 5/32" x 3 1/2"	1	TDB312
Drill Bit 5/32" x 4 1/2"	1	TDB412

Soffit Vent Screws

Description	Quantity	Stock #
#6 1/2"	100	SVS126

Wood Screws

Description	Quantity	Stock #
#4 1/2" Phillips Head	100	PHS124
#4 3/4" Phillips Head	100	PHS344
#6 3/4" Phillips Head	100	PHS346
#6 1" Phillips Head	100	PHS16
#6 1" Slot	10	FHS16
#6 1 1/4" Phillips Head	100	PHS1146
#6 1 1/4" Slot	12	FHS1146
#6 1 1/2" Slot	12	FHS1126
#8 3/4" Phillips Head	100	PHS348
#8 1" Phillips Head	100	PHS18
#8 1" Slot	20	FHS18
#8 1 1/4" Phillips Head	100	PHS1148
#8 1 1/4" Slot	15	FHS1148
#8 1 1/2" Phillips Head	100	PHS1128
#8 1 3/4" Phillips Head	100	PHS1348
#8 2" Phillips Head	100	PHS28
#10 3/4" Slot	15	FHS3410
#10 1" Slot	15	FHS110
#10 1 1/4" Slot	100	FHS11410
#10 1 1/4" Slot	12	FHS11410D
#10 1 1/2" Phillips Head	100	PHS11210
#10 1 3/4" Phillips Head	100	PHS13410
#10 2" Phillips Head	100	PHS210
#10 2 1/2" Phillips Head	100	PHS21210
#12 3/4" Slot	10	FHS3412D
#12 1" Slot	10	FHS112
#12 1 1/4" Phillips Head	100	PHS11412
#12 1 1/2" Phillips Head	100	PHS11212
#12 1 3/4" Slot	100	FHS13412
#12 1 3/4" Slot	6	FHS13412D
#12 2" Phillips Head	100	PHS212
#12 2 1/2" Slot	4	FHS21212
#12 2 1/2" Phillips Head	100	PHS21212



Drywall Screws

Description	Quantity	Stock #
#6 1"	100	DS1D
#6 1"	10,000	DS1B
#6 1"	5#	1DS5
#6 1 1/4"	90	DS114D
#6 1 1/4"	8,000	DS114B
#6 1 1/4"	5#	114DS5
#6 1 5/8"	65	DS158D
#6 1 5/8"	5,000	DS158B
#6 1 5/8"	5#	158DS5
#6 2"	50	DS2D
#6 2"	3,500	DS2B
#6 2"	5#	2DS5
#7 2 1/2"	5#	212DS5
#8 2 1/2"	30	DS212D
#8 2 1/2"	2,500	DS212B
#8 3"	25	DS3D
#8 3"	2,000	DS3B
#8 3"	5#	3DS5



Lag Screws

Description	Quantity	Stock #
1/4" x 1 1/4"	100	14LS114
1/4" x 1 1/2"	100	14LS112
1/4" x 2"	100	14LS2
1/4" x 2 1/2"	100	14LS212
1/4" x 3"	100	14LS3
5/16" x 1 1/2"	100	516LS112
5/16" x 2"	100	516LS2
5/16" x 2 1/2"	100	516LS212
5/16" x 3"	100	516LS3
5/16" x 3 1/2"	50	516LS312
5/16" x 4"	50	516LS4
5/16" x 6"	50	516LS6
3/8" x 3"	50	38LS3
3/8" x 3 1/2"	50	38LS312
3/8" x 4"	50	38LS4
3/8" x 5"	50	38LS5
3/8" x 5 1/2"	50	38LS512
3/8" x 6"	50	38LS6
1/2" x 4"	25	12LS4
1/2" x 4 1/2"	25	12LS412
1/2" x 5"	25	12LS5
1/2" x 6"	25	12LS6
1/2" x 8"	25	12LS8
1/2" x 10"	25	12LS10



Fine Thread Screws

Description	Quantity	Stock #
1 1/4"	100	DSFT114
1 1/4"	1,000	DSFT114C
1 5/8"	100	DSFT158
1 5/8"	700	DSFT158C
2 1/4"	100	DSFT214
2 1/4"	400	DSFT214C

BOLTS

Thunderbolt

Description	Quantity	Stock #
$\frac{3}{8}$ " x 3"	50	38TB3
$\frac{1}{2}$ " x 4"	25	12TB4



Carriage Bolts

Description	Quantity	Stock #
$\frac{3}{8}$ " x 4"	50	38CB4
$\frac{3}{8}$ " x 6"	50	38CB6
$\frac{3}{8}$ " x 8"	50	38CB8
$\frac{3}{8}$ " x 10"	50	38CB10
$\frac{1}{2}$ " x 4"	25	12CB4
$\frac{1}{2}$ " x 6"	25	12CB6
$\frac{1}{2}$ " x 8"	25	12CB8
$\frac{1}{2}$ " x 10"	25	12CB10



Toggle Bolts

Description	Quantity	Stock #
$\frac{1}{8}$ " x 3"	50	18TB3
$\frac{3}{16}$ " x 3"	50	316TB3
$\frac{1}{4}$ " x 4"	50	14TB4



Nuts

Description	Quantity	Stock #
$\frac{3}{8}$ "	100	38N
$\frac{1}{2}$ "	50	12N



Washers

Description	Quantity	Stock #
$\frac{1}{4}$ "	Individual	W14
$\frac{5}{16}$ "	Individual	W516
$\frac{3}{8}$ "	Individual	W38
$\frac{1}{2}$ "	Individual	W12

CONNECTORS



LUP Pronged Joist Hanger

Joist Size	Height	Stock #
2" x 4"	3 $\frac{1}{8}$ "	LUP24
2" x 6" - 2" x 8"	4 $\frac{3}{4}$ "	LUP26
2" x 8" - 2" x 10"	6 $\frac{5}{8}$ "	LUP28
2" x 10" - 2" x 14"	7 $\frac{13}{16}$ "	LUP210

LUS Double Joist Hanger

Joist Size	Height	Stock #
Double 2" x 6" - 2" x 8"	3 $\frac{1}{8}$ "	LUS262
Double 2" x 8" - 2" x 10"	3 $\frac{1}{8}$ "	LUS282
Double 2" x 10" - 2" x 12"	4 $\frac{5}{8}$ "	LUS2102

LVL Joist Hanger

Joist Size	Height	Stock #
4" x 10" - 4" x 12"	9 $\frac{1}{2}$ " - 11 $\frac{7}{8}$ "	LVL410



SUR/SUL Skewed 45° Hanger

Joist Size	Height	Stock #
2" x 4"	3 $\frac{1}{8}$ "	SUR/SUL 24
2" x 10" - 2" x 12"	8 $\frac{1}{8}$ "	SUR/SUL 210
Double 2" x 10" - 12"	8 $\frac{11}{16}$ "	SUR/SUL 210-2



LSU Field Skewed Hanger

Joist Size	Height	Stock #
2" x 10" Minimum	9 $\frac{1}{2}$ "	LSU26

Truss Hanger

Width	Height	Stock #
1 $\frac{5}{8}$ "	9 $\frac{11}{16}$ "	THA29



HRT Hurricane Tie

Width	Height	Stock #
1 $\frac{9}{16}$ "	5 $\frac{7}{16}$ "	H25



Post Cap/Base

Length	Width	Height	Stock #
3 $\frac{9}{16}$ "	2 $\frac{7}{8}$ "	3"	BC4



Half Base

Length	Width	Height	Stock #
3 $\frac{9}{16}$ "	3 $\frac{1}{6}$ "	3 $\frac{1}{4}$ "	BC40
5 $\frac{1}{2}$ "	5 $\frac{1}{2}$ "	3"	BC60



Adjustable Post Base

Width	Height	Stock #
3 1/16"	3 1/16"	AB44
5 1/2"	5 9/16"	AB66



Elevated Post Base

Width	Length	Height	Stock #
3 9/16"	3 1/16"	2 5/16"	EPB44

Column Base (Aluminum)

Description	Stock #
4" x 4"	ACB4
6" x 6"	ACB6
8" x 8"	ACB8
10" x 10"	ACB10
12" x 12"	ACB12



Fence Bracket

Size	Width	Height	Base	Stock #
2" x 6"	1 1/16"	3 3/8"	3/16"	FB24

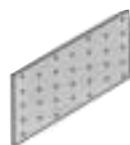

Tie Plate

Width	Height	Stock #
3 1/8"	5"	TP35



T-Strap

Length	Height	Base	Stock #
6"	5"	1 1/2"	66T

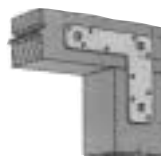

L-Strap

Length	Height	Base	Stock #
6"	6"	1 1/2"	66L



Wall Braces

Length	Angle & Wall Size	Stock #
11 1/4"	5"	TWB
11"	3 3/4"	SWB



Staircase Angle

Stringer	Tread	Stock #
3-SDS 1/4" x 1 1/2"	2-SDS 5/8" x 1 1/2"	TA9



Framing Anchor

Length	Stock #
11"	A35



H Clips

Length	Quantity	Stock #
7/16"	250 per box	HC716
1/2"	250 per box	HC12
5/8"	250 per box	HC58
3/4"	250 per box	HC34



Bridging

Description	Stock #
NC 2" x 10" - 16"	NC1016
NC 2" x 10" - 16"	NC1012
NCA 2" x 12" - 16"	NC1216



Shelf Bracket

Description	Stock #
6" x 8" Grey	SB68
8" x 10" Grey	SB810
10" x 12" Grey	SB1012
12" x 14" Grey	SB1214

The connectors listed are inventory items. For other types of connectors, see the *Simpson Wood Construction Connectors* catalog.

Web Links
 Simpson Strong-Tie
www.strongtie.com



#80 Standard

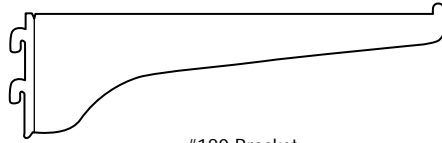

#180 Bracket

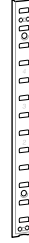

#255 Standard

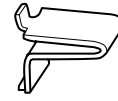

#256 Support

Zinc Shelf Standards and Supports

Description	Length	Stock#
KV Standard #255 Zinc	48"	255Z48
KV Standard #255 Zinc	72"	255Z72
KV Standard #255 Zinc	96"	255Z96

Description	Stock#
KV Shelf Support #256 Zinc	256Z

Brass Shelf Standards, Supports, and Brackets

Description	Length	Stock#
KV Standard #255 Brass	48"	255BR48
KV Standard #255 Brass	72"	255BR72
KV Standard #255 Brass	96"	255BR96
KV Standard #80 Brass	24"	80BR24
KV Standard #80 Brass	36"	80BR36
KV Standard #80 Brass	48"	80BR48
KV Standard #80 Brass	60"	80BR60
KV Standard #80 Brass	72"	80BR72

Description	Stock#
KV Shelf Support #256 Brass	256BR

Description	Length	Stock#
KV Bracket #180 Brass	6"	180BR6
KV Bracket #180 Brass	8"	180BR8
KV Bracket #180 Brass	10"	180BR10
KV Bracket #180 Brass	12"	180BR12

Brown Shelf Standards and Supports

Description	Length	Stock#
KV Standard #255 Brown	48"	255B48
KV Standard #255 Brown	60"	255B60
KV Standard #255 Brown	72"	255B72
KV Standard #255 Brown	96"	255B86

Description	Stock#
KV Shelf Support #256 Walnut	256W

Aluminum Shelf Standards and Brackets

Description	Length	Stock#
KV Standard #80 Aluminum	24"	80A24
KV Standard #80 Aluminum	36"	80A36
KV Standard #80 Aluminum	48"	80A48
KV Standard #80 Aluminum	60"	80A60
KV Standard #80 Aluminum	72"	80A72

Description	Length	Stock#
KV Bracket #180 Aluminum	6"	180A6
KV Bracket #180 Aluminum	8"	180A8
KV Bracket #180 Aluminum	10"	180A10
KV Bracket #180 Aluminum	12"	180A12

Black Shelf Standards and Brackets

Description	Length	Stock#
KV Standard #80 Black	24"	80BL24
KV Standard #80 Black	36"	80BL36
KV Standard #80 Black	48"	80BL48
KV Standard #80 Black	60"	80BL60
KV Standard #80 Black	72"	80BL72

Description	Length	Stock#
KV Bracket #180 Black	6"	180BL6
KV Bracket #180 Black	8"	180BL8
KV Bracket #180 Black	10"	180BL10
KV Bracket #180 Black	12"	180BL12

Bronze Shelf Standards and Brackets

Description	Length	Stock#
KV Standard #80 Bronze	24"	80B224
KV Standard #80 Bronze	36"	80B236
KV Standard #80 Bronze	48"	80B248
KV Standard #80 Bronze	60"	80B260
KV Standard #80 Bronze	72"	80B272

Description	Length	Stock#
KV Bracket #180 Bronze	6"	180B26
KV Bracket #180 Bronze	8"	180B28
KV Bracket #180 Bronze	10"	180B210
KV Bracket #180 Bronze	12"	180B212

For other related products, see the following:

	Page
Boards — Spruce and Pine	7
Particle Board Shelving	13
Screws	40-41