

D1

K1

**Stanley Pre-Hung Steel Doors**

Description	Stock #
D1 2' 8" x 6' 8" Right-Hand Hinge	28D1RH
D1 2' 8" x 6' 8" Right-Hand Hinge Deadbolt	28D1RHD
D1 3' x 6' 8" Right-Hand Hinge Deadbolt	30D1RHD

D1 2' 8" x 6' 8" Left-Hand Hinge	28D1LH
D1 2' 8" x 6' 8" Left-Hand Hinge Deadbolt	28D1LHD
D1 3' x 6' 8" Left-Hand Hinge Deadbolt	30D1LHD

K1 2' 8" x 6' 8" Right-Hand Hinge	28K1RH
K1 2' 8" x 6' 8" Right-Hand Hinge Deadbolt	28K1RHD
K1 3' x 6' 8" Right-Hand Hinge	30K1RH
K1 3' x 6' 8" Right-Hand Hinge Deadbolt	30K1RHD

K1 2' 8" x 6' 8" Left-Hand Hinge	28K1LH
K1 2' 8" x 6' 8" Left-Hand Hinge Deadbolt	28K1LHD
K1 3' x 6' 8" Left-Hand Hinge	30K1LH
K1 3' x 6' 8" Left-Hand Hinge Deadbolt	30K1LHD



The doors listed are inventory items. A comprehensive selection of doors is available, including oak, maple, mahogany, and other species. We also offer fiberglass and steel doors, as well as doors with leaded glass, brass caning, and etching.

Stanley Doors

Karona Doors

**Hardwood Doors**

**FLOORING**

**D & Better Southern Yellow Pine (SYP)**

	6'	8'	10'	12'	14'	16'
1 x 4	146FLG	148FLG	1410FLG	1412FLG	1414FLG	1416FLG
1 x 6	166FLG	168FLG	1610FLG	1612FLG	1614FLG	1616FLG

**Oak Flooring**

#1 Common Red Oak flooring – 19.5 Square Foot/Bundle

1" x 3" (13FLG)



Bruce Hardwood Flooring, Sommerset Flooring, and Columbia SnapLock Laminate Flooring are available from Requarth Lumber by special order. Contact a sales representative for a catalog.



**Full Round Redwood Window Louvers**

Width	Rough Opening Height	Stock #
1' 10"	1' 10"	FRL905
2' 2"	2' 2"	FRL1000

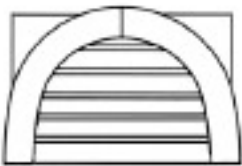

**Half Round Redwood Window Louvers**

Width	Rough Opening Height	Stock #
2' 6"	1' 5 1/4"	HRL1100
3' 2"	1' 9 1/4"	HRL1110

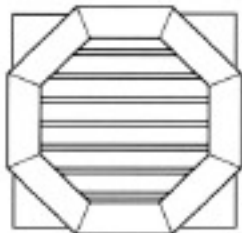

**Octagonal Redwood Window Louvers**

Width	Rough Opening Height	Stock #
1' 10"	1' 10"	OCT1300

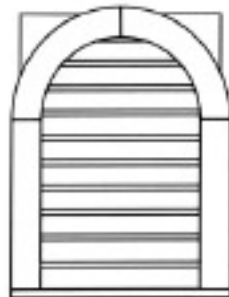

**Cathedral Style Redwood Window Louvers**

Width	Rough Opening Height	Stock #
1' 10"	2' 6 1/2"	C30

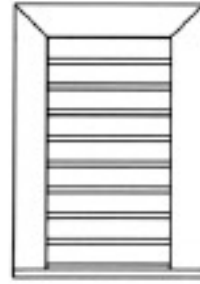

**Deluxe Rectangular Redwood Window Louvers**

Width	Rough Opening Height	Stock #
1' 4 1/2"	2' 1/2"	RL1420
1' 4 1/2"	2' 6 1/2"	RL1426
2' 1/2"	3' 1/2"	RL2030

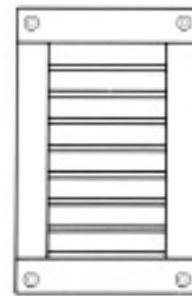

**Economy Rectangular Redwood Window Louvers**

Width	Rough Opening Height	Stock #
1' 1/2"	1' 4 1/2"	RL1014
1' 1/2"	2' 1/2"	RL1020

**Hardwood Door Louvers**

Description	Stock#
24" x 12" x 1 3/8"	DLV241238
24" x 12" x 1 3/4"	DLV241234

**Hardwood Door Lites**

Description	Stock#
10" x 10" x 1 3/8"	DLT101038
20" x 24" x 1 3/8"	DLT202438
4" x 48" x 1 3/4"	DLT44834
10" x 10" x 1 3/4"	DLT101034
20" x 24" x 1 3/4"	DLT202434
24" x 36" x 1 3/4"	DLT243634

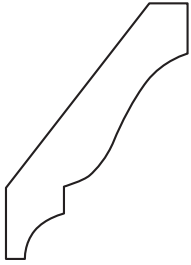

**Crown Moulding**

Size	Species	Stock#
$1\frac{3}{16}'' \times 5\frac{1}{4}''$	Poplar	P47
$1\frac{3}{16}'' \times 4\frac{1}{4}''$	Poplar	P48
$1\frac{3}{16}'' \times 3\frac{5}{8}''$	Poplar	P49

$1\frac{1}{16}'' \times 3\frac{5}{8}''$	Red Oak	RO49
---	---------	------

$1\frac{1}{16}'' \times 5\frac{1}{4}''$	White Pine	WM47
$1\frac{1}{16}'' \times 4\frac{1}{4}''$	White Pine	WM48
$\frac{9}{16}'' \times 3\frac{5}{8}''$	White Pine	WM49
$1\frac{1}{16}'' \times 3\frac{1}{4}''$	White Pine	WM51
$\frac{9}{16}'' \times 2\frac{1}{4}''$	White Pine	WM54
$\frac{9}{16}'' \times 1\frac{3}{4}''$	White Pine	WM74

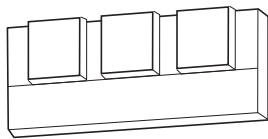

**Dentil Moulding**

Size	Species	Stock#
$1\frac{1}{16}'' \times 2\frac{1}{2}''$	White Pine	WPDM

$1\frac{1}{16}'' \times 2\frac{1}{2}''$	Poplar	PDM
---	--------	-----

$1\frac{1}{16}'' \times 2\frac{1}{2}''$	Red Oak	RODM
---	---------	------

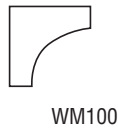
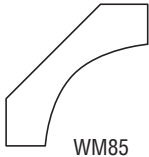

**Cove Moulding**

Size	Species	Stock#
$\frac{9}{16}'' \times 1\frac{3}{4}''$	White Pine	WM85
$1\frac{1}{16}'' \times 1\frac{1}{8}''$	White Pine	WM94
$1\frac{1}{16}'' \times 1\frac{1}{16}''$	White Pine	WM100

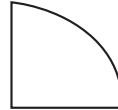

**Quarter Round**

Size	Species	Stock#
$1\frac{1}{16}''$	White Pine	WM106
$\frac{1}{2}''$	White Pine	WM108
$\frac{1}{4}''$	White Pine	WM110

$\frac{3}{4}''$	Poplar	P105
-----------------	--------	------

$\frac{3}{4}''$	Red Oak	RO105
-----------------	---------	-------



**Half Round**

Size	Species	Stock#
$\frac{1}{2}'' \times 1''$	White Pine	WM120
$\frac{5}{16}'' \times \frac{5}{8}''$	White Pine	WM123



**Shoe Moulding**

Size	Species	Stock#
$\frac{1}{2}'' \times \frac{3}{4}''$	White Pine	WM126

$\frac{1}{2}'' \times \frac{3}{4}''$	Poplar	P126
--------------------------------------	--------	------

$\frac{1}{2}'' \times \frac{3}{4}''$	Red Oak	RO126
--------------------------------------	---------	-------

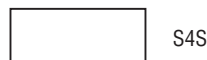

**Screen Stock**

Size	Species	Stock#
$\frac{3}{4}'' \times \frac{3}{4}''$	White Pine	WM239
$1\frac{1}{16}'' \times 2\frac{3}{4}''$	White Pine	WM246
$1\frac{1}{16}'' \times 1\frac{3}{4}''$	White Pine	WM248
$\frac{1}{2}'' \times \frac{3}{4}''$	White Pine	WM254

$\frac{3}{4}'' \times \frac{3}{4}''$	Poplar	P239
--------------------------------------	--------	------

$\frac{3}{4}'' \times 1\frac{1}{2}''$	Poplar	P250
---------------------------------------	--------	------

$\frac{1}{2}'' \times \frac{3}{4}''$	Poplar	P254
--------------------------------------	--------	------

$\frac{3}{4}'' \times \frac{3}{4}''$	Red Oak	RO239
--------------------------------------	---------	-------

$\frac{3}{4}'' \times 1\frac{1}{2}''$	Red Oak	RO250
---------------------------------------	---------	-------

$\frac{1}{2}'' \times \frac{3}{4}''$	Red Oak	RO254
--------------------------------------	---------	-------

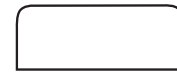

**Screen Mould**

Size	Species	Stock#
$\frac{1}{4}'' \times \frac{3}{4}''$	White Pine	WM142

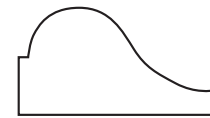

**Bed Moulding**

Size	Species	Stock#
$1\frac{1}{16}'' \times 1\frac{1}{4}''$	White Pine	WM166

$\frac{9}{16}'' \times 2\frac{1}{4}''$	Poplar	P72
$\frac{9}{16}'' \times 1\frac{3}{4}''$	Poplar	P74

$\frac{3}{4}'' \times 2\frac{1}{4}''$	Cedar	214CBM
---------------------------------------	-------	--------

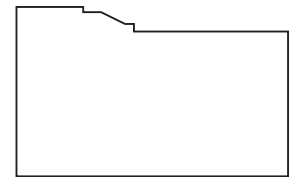

**Brick Moulding**

Size	Species	Stock#
$1\frac{1}{4}'' \times 2''$	White Pine	WM180



**Stool Moulding**

Size	Species	Stock#
Stool DH $1\frac{1}{16}'' \times 3\frac{1}{4}''$	White Pine	WM1193
Casement Stool $3\frac{1}{4}''$	White Pine	314PS



**Drip Cap Moulding**

Size	Species	Stock#
$1\frac{1}{16}'' \times 1\frac{5}{8}''$	White Pine	WM197

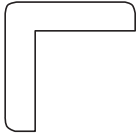

**Outside Corner**

Size	Species	Stock#
1 1/8"	White Pine	WM205
3/4"	White Pine	WM206
3/4"	Red Oak	RO206



**Shingle Mould**

Size	Species	Stock#
9/16" x 1 3/4"	White Pine	WM210



WM291



WM292

**Cap Mould**

Size	Species	Stock#
9/16" x 1 1/16"	White Pine	WM291
9/16" x 1 1/8"	White Pine	WM292

**Base Cap Mould**

Size	Species	Stock#
3/4" x 1 1/2"	Poplar	PBC112
9/16" x 3/4"	Poplar	PBC916
11/16" x 7/8"	Poplar	PBC78
11/16" x 7/8"	Red Oak	ROBC

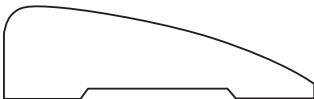

**Ranch Casing**

Size	Species	Stock#
1 1/16" x 2 1/4"	White Pine	WM327



WM444

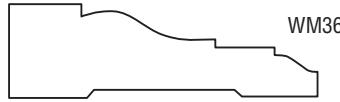

WM366

**Colonial Casing – White Pine**

Size	Species	Stock#
1 1/16" x 3 1/2"	White Pine	WM444
1 1/16" x 2 1/4"	White Pine	WM366

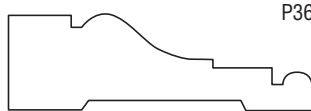

P361

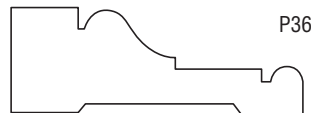

P366



P341

**Colonial Casing – Poplar**

Size	Species	Stock#
1 3/16" x 2 5/8"	Poplar	P361
1 3/16" x 2 1/4"	Poplar	P366
1 3/16" x 3 1/2"	Poplar	P341

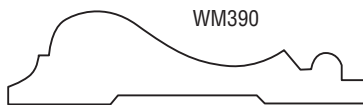

WM390

**Chair Rail**

Size	Species	Stock#
1 1/16" x 2 5/8"	White Pine	WM390
7/16" x 2 1/4"	White Pine	WM493
1 1/16" x 2 1/4"	Poplar	PCR
1 1/16" x 2 1/4"	Red Oak	ROCR

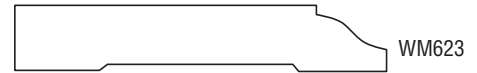

WM623

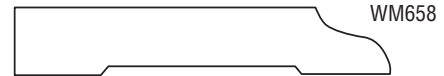

WM658

**Colonial Base – White Pine**

Size	Species	Stock#
9/16" x 3 1/4"	White Pine	WM623
9/16" x 5 1/4"	White Pine	WM658

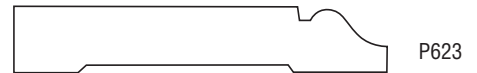

P623



P603

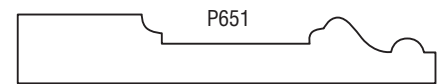

P651

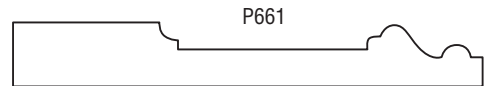

P661

**Colonial Base – Poplar**

Size	Species	Stock#
9/16" x 3 1/4"	Poplar	P623
1 1/16" x 3 1/4"	Poplar	P603
1 1/16" x 4 1/4"	Poplar	P651
1 1/16" x 5 1/4"	Poplar	P661



**Ranch Base**

Size	Species	Stock#
9/16" x 3 1/4"	White Pine	WM713



**Ranch Stop**

Size	Species	Stock#
7/16" x 1 3/8"	White Pine	WM816



*The Requarth Mill can produce custom mouldings for residential and commercial projects.*



**Round Corner Stop**

Size	Species	Stock#
7/16" x 1 1/4"	Poplar	P867

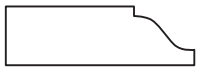

**Colonial Stop**

Size	Species	Stock#
7/16" x 1 1/4"	White Pine	WM937
7/16" x 1 1/4"	Poplar	P926



**Beaded Ceiling**

Size	Species	Stock#
5/8" x 3 1/4"	Yellow Pine	58BEAD
9/16" x 3 1/4"	Poplar	PBC
9/16" x 3 1/4"	White Pine	WPBC

**Glass Bead**

Size	Species	Stock#
5/8" x 1"	Red Oak	ROGB
5/8" x 1"	Birch	BGB



WM989



WM978

**Panel Mould**

Size	Species	Stock#
3/8" x 1 1/8"	White Pine	WM989
3/8" x 1 3/8"	White Pine	WM978

**Primed Mouldings**

Description	Stock#
#361 3 1/2" Colonial Casing	LWM361PR
#366 Finger-jointed Casing	WM366PR
#623 Colonial Base	WM623PR
T927 9/16" x 4 1/4" Finger-jointed Base	WM927PR
SM3918 5 1/4" Base	SM3918PR



**Scotia**

Size	Species	Stock#
5/8" x 13/16"	Poplar	P96
5/8" x 13/16"	Red Oak	R096

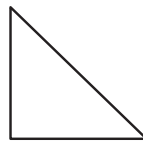

**Chamfer Moulding**

Size	Species	Stock#
3/4" x 3/4"	White Pine	WM995
3/4" x 3/4"	Poplar	P995

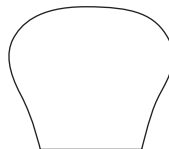

**Handrail**

Size	Species	Stock#
1 1/2" x 1 11/16"	White Pine	WM230
1 5/8" x 1 3/4"	Red Oak	RO231

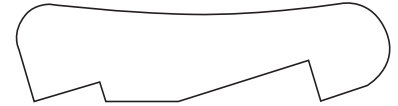

**Bar Rail**

Size	Species	Stock#
1 3/4" x 6 3/4"	Poplar	PBR
1 3/4" x 6 3/4"	Red Oak	ROBR

**Jamb Stock**

Size	Species	Stock#
4 9/16"	Poplar	PJ4
4 9/16"	Poplar	PJ4S

**Threshold**

Size	Species	Stock#
3 1/2" x 3"	Red Oak	ROTH3
3 1/2" x 4"	Red Oak	ROTH4
3 1/2" x 6"	Red Oak	ROTH6

**For other related products, see the following:**

	Page
Boards — Spruce and Pine . . . .	7
Boards — Hardwood . . . . .	8
Plywood — Hardwood . . . . .	11
Adhesives . . . . .	47



*The Requarth mill can manufacture a wide variety of wood products for residential, commercial, and industrial use.*

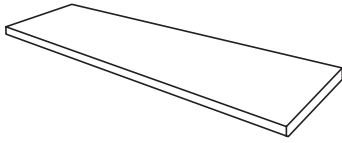

**Stair Treads**

Size	Species	Stock#
11" x 36"	#1 Yellow Pine	3YPT
11" x 42"	#1 Yellow Pine	36YPT
11" x 48"	#1 Yellow Pine	4YPT

11 1/4" x 36"	Red Oak	3ROT
11 1/4" x 42"	Red Oak	36ROT
11 1/4" x 48"	Red Oak	4ROT
11 1/4" x 60"	Red Oak	5ROT

10 1/2" x 48"	Poplar	LJ807048
10 1/2" x 60"	Poplar	LJ807060

11 1/2" x 48"	Particle Board	4PBT
---------------	----------------	------

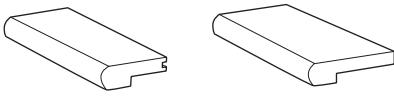

LJ80905

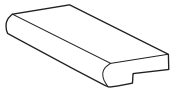

LJ8090

**Stair Treads — Landing**

Size	Species	Stock#
3 1/4"	#1 Yellow Pine	YLT

3 1/2"	Red Oak	ROLT
--------	---------	------

3 1/2"	Poplar	LJ8090
--------	--------	--------

5 1/2"	Poplar	LJ80905
--------	--------	---------

**Stair Treads — Return**

Size	Species	Stock#
1 1/4" x 1' 2"	Red Oak	ROTR

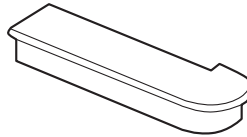

**Stair Treads — Starting Step**

Size	Species	Stock#
48"	Poplar	LJ8010

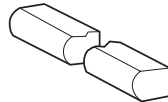

**Lineal Nosing**

Size	Species	Stock#
1 1/16" x 1 1/4"	Poplar	LJ8080

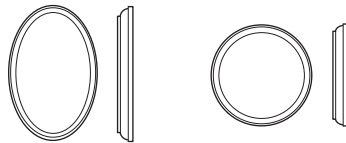

**Rosettes**

Description	Species	Stock#
Round	Red Oak	C7317
Oval	Red Oak	C7337

Round	Poplar	LJ7026
Oval	Poplar	LJ7027



C4004BT



C4005BT



C4040BT



C4045BT

**Ball Top Newels**

Size	Species	Stock#
3" x 48"	Red Oak	C4040BT
3" x 60"	Red Oak	C4045BT
3 1/2" x 48"	Red Oak	C4004BT
3 1/2" x 60"	Red Oak	C4005BT

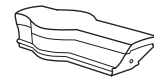

LJ7020

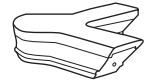

LJ7021



LJ7030

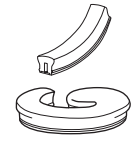

LJ7035

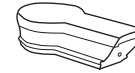

LJ7019

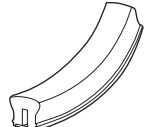

LJ7012



LJ7011



LJ70RD



LJ7008

**Upeasings, Caps, and Quarterturns**

Model #	Species	Stock#
LJ-7020 Tandem Cap	Poplar	LJ7020
LJ-7021 Quarterturn w/Cap	Poplar	LJ7021
LJ-7012 Upeasing	Poplar	LJ7012
LJ-7030 Volute (Left-hand)	Poplar	LJ7030
LJ-7035 Volute (Right-hand)	Poplar	LJ7035
LJ-7008 Coped End	Poplar	LJ7008
LJ-7019 Opening Cap	Poplar	LJ7019
LJ-7011 Quarterturn w/o Cap	Poplar	LJ7011
LJ-70RD Rail Drop	Poplar	LJ70RD



LJ4010, LJ4014,  
LJ4015, LJ4017



LJ4040, LJ4042

**Utility/Landing Newels**

Model #	Species	Stock#
LJ-4010 (43") Utility	Poplar	LJ4010
LJ-4014 (50") Utility	Poplar	LJ4014
LJ-4015 (58") Landing	Poplar	LJ4015
LJ-4017 (65") Landing	Poplar	LJ4017

LJ-4040 (48") Utility	Poplar	LJ4040
LJ-4042 (58") Utility	Poplar	LJ4042

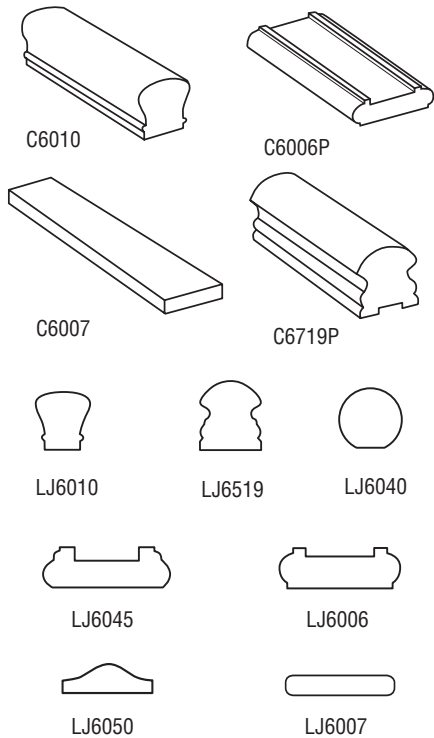

**Rails and Fillets**

Description	Species	Stock#
Traditional Rail	Red Oak	C6010
Hampton Shoe Rail with Plow 1 3/4"	Red Oak	C6006P
Hampton Fillet 1 3/4"	Red Oak	C6007
Marion Rail with Plow	Red Oak	C6719

LJ-6010 Handrail	Poplar	LJ6010
LJ-6519 Handrail w/plow	Poplar	LJ6519P
LJ-6040 Wall Rail	Poplar	LJ6040
LJ-6045 Shoe Rail 1 1/4"	Poplar	LJ6045
LJ-6006 Shoe Rail 1 3/4"	Poplar	LJ6006
LJ-6050 Fillet 1 1/4"	Poplar	LJ6050
LJ-6007 Fillet 1 3/4"	Poplar	LJ6007

**Attic Ladder**

Disappearing attic stairs, 250 lb capacity.

Description	Stock #
22" x 54", 8'9"	DS2289
22" x 54", 10'-0"	DS2210
25" x 54", 8'9"	DS2589
25" x 54", 10'-0"	DS2510
30" x 54", 8'9"	DS3089

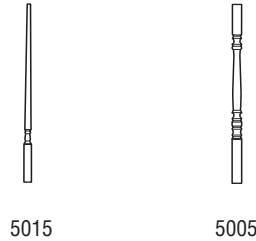

**Traditional Balusters**

Size	Species	Stock#
31-Inch	Red Oak	C501531
34-Inch	Red Oak	C501534
36-Inch	Red Oak	C501536
31-Inch Primed	Varies	C501531P
34-Inch Primed	Varies	C501534P
36-Inch Primed	Varies	C501536P
39-Inch Primed	Varies	C501539P
30-Inch Hampton	Red Oak	C500530
36-Inch Hampton	Red Oak	C500536

34-Inch (1 1/4")	Poplar	LJ501534
38-Inch (1 1/4")	Poplar	LJ501538
42-Inch (1 1/4")	Poplar	LJ501542

34-Inch (1 3/4")	Poplar	LJ500534
38-Inch (1 3/4")	Poplar	LJ500538
42-Inch (1 3/4")	Poplar	LJ500542



**Dowel-Fast Kit**

Pack of 50 – used to attach balusters to treads and landing tread.

Description	Stock #
5/16" x 2 1/2" Full Thread Dowel Screws	LJ3076

**For other related products, see the following:**

	Page
Boards — Hardwood . . . . .	8
Plywood — Hardwood . . . . .	11
Adhesives . . . . .	47

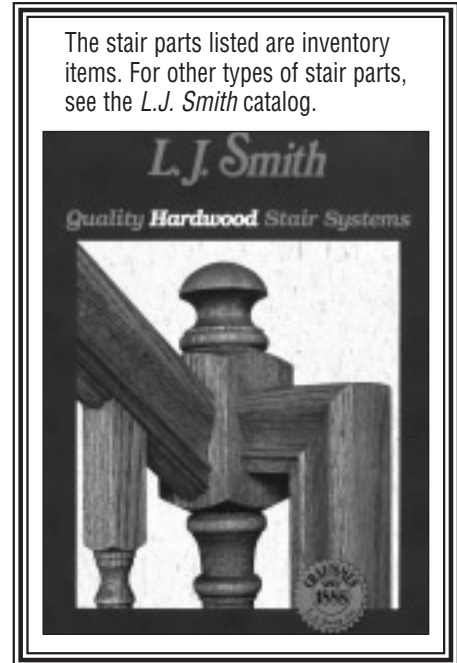

**Web Links**  
 L.J. Smith  
 www.ljsmithstairs.com